



SOSEN LED Driver, Your Smart Choice

Specifications

SS-150GA Series LED Driver

Model: SS-150GA-56*

Description: 150W LED Driver

Rev.: V01

Release Date: 2019-07-20

SS-150GA Series LED Driver

SOSEN
LED DRIVER



LED DRIVER

GA Series



Features:

- Efficiency up to 92%
- Isolated dimming: 1-10V, PWM, Resistor
- IP67
- Protections: SCP/OTP/OVP/OPP
- Surge protection: L/N-PE: 10kV, L-N: 6kV
- Warranty: 5 years



CB CE IP67

Description:

The SS-150GA series is 150W, constant current, outdoor LED drivers with built-in surge protection circuits. This driver is specially designed for LED lighting such as high bay, high mast, stage and street lighting. Aluminum case and full potted thermal conductive silicon glue technology ensure good heat dissipation and waterproof performance. Newly isolated dimming solution is adopted and in the meantime it has automatic power reduction protection when the input voltage is low or the driver is working over temperature. Comprehensive protections greatly improve product safety and reliability.

Model List:

Model	AC Input Range	Max. Pout	Vout Range	Full Power Vo Range	Iout	THD(Typ.)	PF(Typ.)	Eff.(Typ.)	Max.Tc
SS-150GA-56*	220-240Vac	150W	22-56V	36-56V	2.1-4.2A	8%	0.98	92%	90°C

1. Default tested at 220Vac, full load, Ta 25°C.

2. "*" Optional B or space in the place of * means additional function.

- Space is the base model without any optional function;
- Suffix B for model with 3-in-1 dimming (1-10V, PWM, Resistor);

SS-150GA Series LED Driver

Input Characteristics:

Parameter	Min.	Typ.	Max.	Remark
Rated AC Input Range	220Vac		240Vac	
Performance Input Voltage Range	200Vac		305Vac	
AC Input Range	100Vac		305Vac	100-200Vac Survived @48hrs
Input Frequency Range	47Hz	50/60Hz	63Hz	
Max Input Current			0.8A	220Vac, Full load
Max Input Power			167W	220Vac, Full load
Max Inrush Current(220Vac)			110A	Cold start
Max Inrush Current(277Vac)			120A	Cold start
No Load Power			3W	220Vac/50Hz, No load
Power Factor	0.96	0.98		220Vac/50Hz, Full load
	0.90			220-240Vac/50Hz, 70-100% load
THD		8%	10%	220Vac/50Hz, Full load
			20%	220-240Vac/50Hz, 70-100% load

SS-150GA Series LED Driver

Output Characteristics:

Parameter	Min.	Typ.	Max.	Remark
Output Voltage Range	22V		56V	Power derated @22-27V
Rated Output Voltage	36V		56V	$P_o=V_o \cdot I_o=150W$, Full load
Rated Output Current	2.6A		4.2A	4.2A for 36V, 2.6A for 56V
Current Adjustable Range(AOC)	2.1A		4.2A	
No Load Voltage			60V	
Efficiency @220Vac	91.0%	92.0%		Output 46V/3.3A
Efficiency @277Vac	91.5%	92.5%		Output 46V/3.3A
Output Current Tolerance	-5%		+5%	
Output Current Ripple(PK-AV)		5%	10%	
Start-up Current Overshoot			10%	Full load
Start-up Time			0.5S	220Vac, Input Voltage & Output Voltage Rataed Value 90%
Line Regulation	-2%		+2%	Full load
Load Regulation	-2%		+2%	
Temperature Coefficient	-0.03%/°C		+0.03%/°C	Tc:0°C~90°C
OTP	90°C	100°C	110°C	Tc, Decreases output current, returning to normal after over temperature is removed.
Short Circuit Protection			10W	Driver will not be damaged, Hiccup mode

SS-150GA Series LED Driver

Other Characteristics:

Parameter	Min.	Typ.	Max.	Remark
1-10V Dimming (Optional)	Dim Vmax	0V		12V
	Dim Range	10%Iomax		100%Ioset
	Rec.Dim Range	1V		10V
PWM Dimming (Optional)	PWM High	9.8V		10.2V
	PWM Low	0V		0.3V
	Frequency	1KHz		2KHz
	PWM Duty	10%		100%
Resistor Dimming (Optional)	Resistance	10Kohm		100Kohm
	Dim Range	10%Iomax		100%Ioset
Lifetime(Tc≤72°C)	≥62,000 hours			80% load
MTBF	200,000 hours			220Vac, Full load, Ta=25°C (MIL-HDBK-217F)
IP Grade	IP67			
Tc	90°C			
Warranty	5 years			Refer to life time drawing
Net Weight	850g			
Dimension	200mm*66mm*39.5mm			L x W x H

NOTE: All the parameters above are tested Ta 25°C, unless specified.

SS-150GA Series LED Driver

Environmental Requirements

Parameter	Min.	Typ.	Max.	Remark
Operating Temperature(Tcase)	-40°C	25°C	+90°C	
Storage Temperature	-40°C	25°C	+85°C	
Operation Humidity	10%RH		90%RH	
Storage Humidity	5%RH		95%RH	
Altitude	-65m		4000m	

Safety and EMI/EMS Standards

Certification	Standard	Status	Remark
ENEC	IEC 61347-2-13:2014/AMD1:2016 used in conjunction with IEC 61347-1:2015	✓	
RCM	AS/NZS61347.2.13	✓	
KC	K61347-1,K61347-2-13	✓	
CCC	GB 19510.14-2009	✓	
CE	EN 61347-2-13:2014 EN61347-1:2008+A1:2011+A2:2013	✓	

EMI/EMS	Criterion	Remark
Conduction Emission	EN55015:2013+A1:2015	
Radiation Emission	EN55015:2013+A1:2015	
Harmonic Current Emissions	IEC/EN 61000-3-2	Class C
Surge	IEC/EN 61000-4-5	Difference mode 6kV, Common mode 10kV,Criterion B
Ring Wave	IEC/EN 61000-4-12	Difference mode 6kV, Common mode 6kV,Criterion B

SS-150GA Series LED Driver

Safety Test Items:

Safety test items	Technical Indicators			Remark
Insulation Requirements	UL Insulation Requirements	TUV Insulation Requirements	CCC Insulation Requirements	
Input-Output	1600Vac	3000Vac	3750Vac	Reinforced insulation
Input-Case	1600Vac	1500Vac	1875Vac	Basic insulation
Input-Dim	1600Vac	3000Vac	3750Vac	Reinforced insulation
Output-Dim	1600Vac	1000Vac	1000Vac	Additional insulation
Output-Case	500Vac	1000Vac	1000Vac	Function insulation
Dim-Case	500Vac	250Vac	250Vac	
Insulation Resistance	≥10MΩ			Input-Output, Test voltage:500Vdc
Ground Resistance	≤0.1Ω			25A/1min
Leak Current	≤0.75mA			277Vac

NOTE:

1. SOSEN warrants the LED Driver itself meets with EMC standard. However, LED Driver's EMC should be re-checked when integrated into lighting systems due to unexpected interference as component.
2. Please short Line and Neutral, LED+ and LED-, Dim+ and Dim - when Hi-pot test.
3. The CCC withstand voltage test needs to disconnect the built-in lightning protection tube. According to the IEC 60598-1:14 standard section 10.2, the "built-in lightning protection tube" can be marked on the nameplate to disconnect the discharge tube on testing.

Performance Curves:

Input Inrush Current

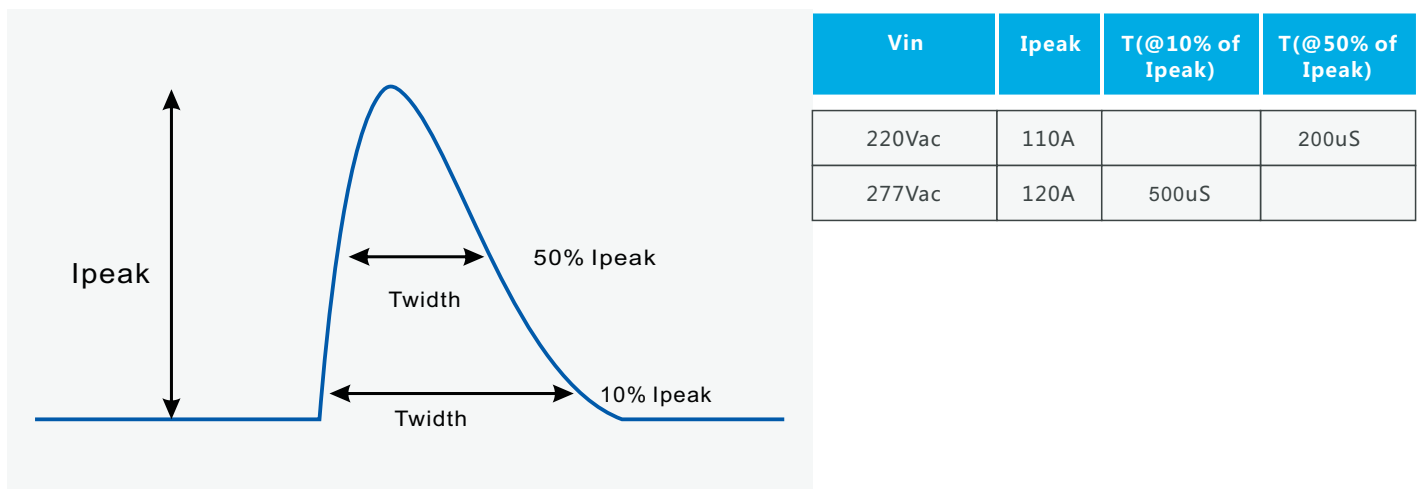

SS-150GA Series LED Driver

Performance Curves:

Output Voltage Vs. Output Current(Dim/AOC Window)

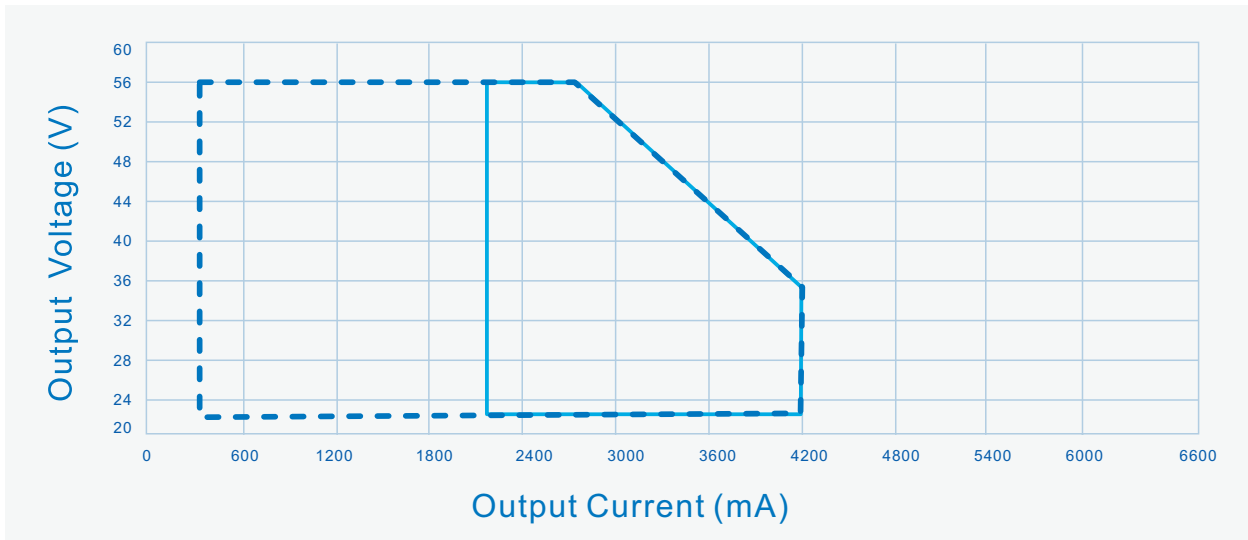

----- Diming Window

————— AOC Window

Efficiency Vs. Output Voltage (Vin=220Vac)

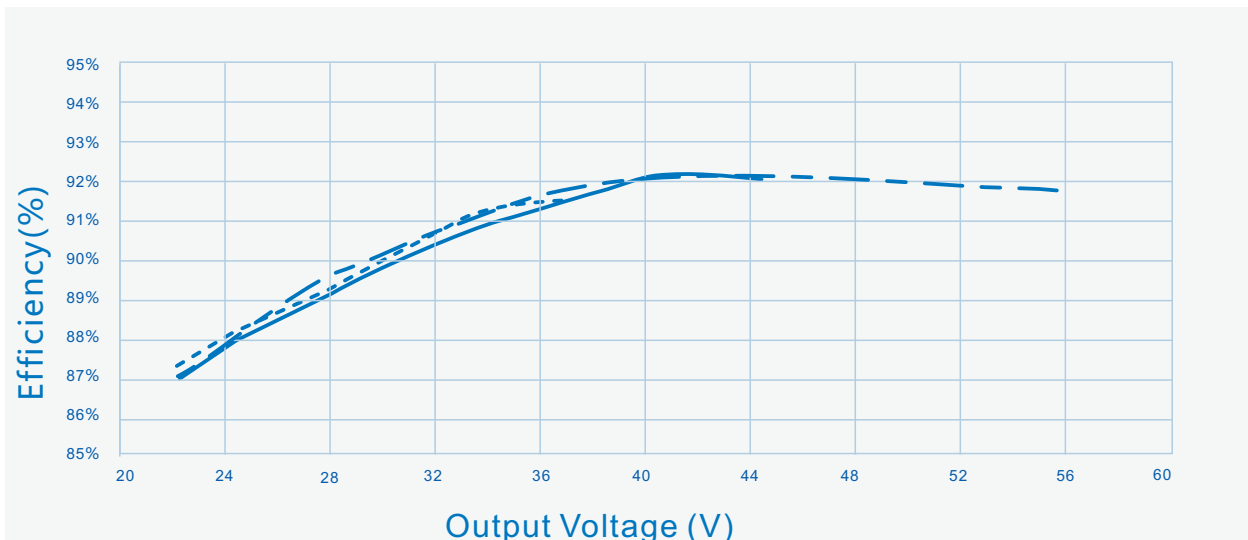

..... Io=4160mA

————— Io=3400mA

- - - - - Io=2670mA

SS-150GA Series LED Driver

Performance Curves:

Efficiency Vs. Output Voltage ($V_{in}=277V_{ac}$)

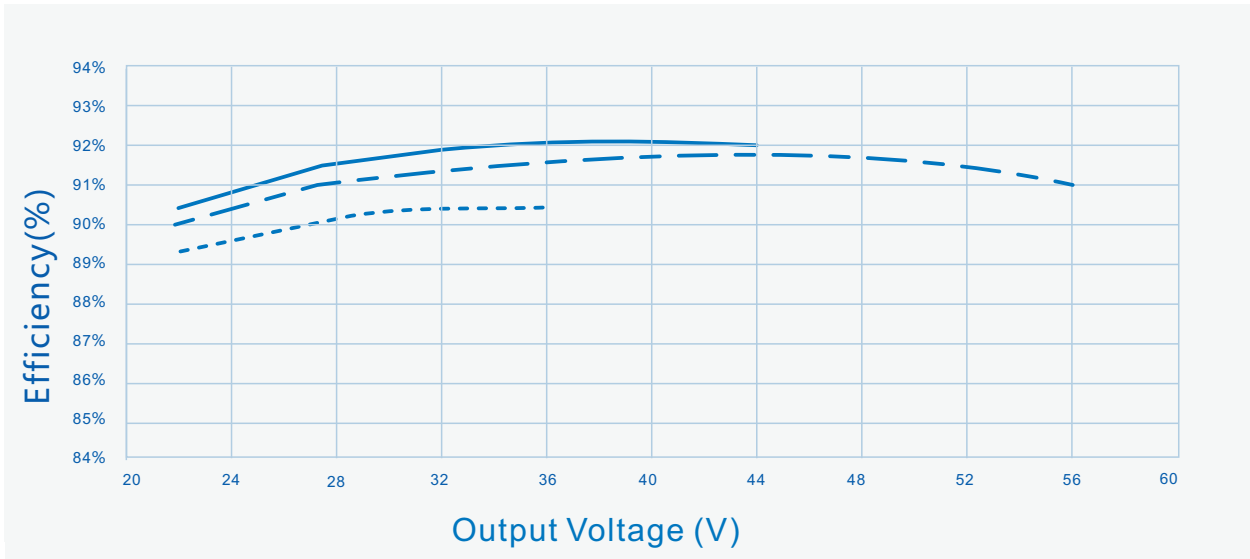

----- $I_o=4160mA$ _____ $I_o=3400mA$ - - - - $I_o=2670mA$

Power Factor Vs. Output Power

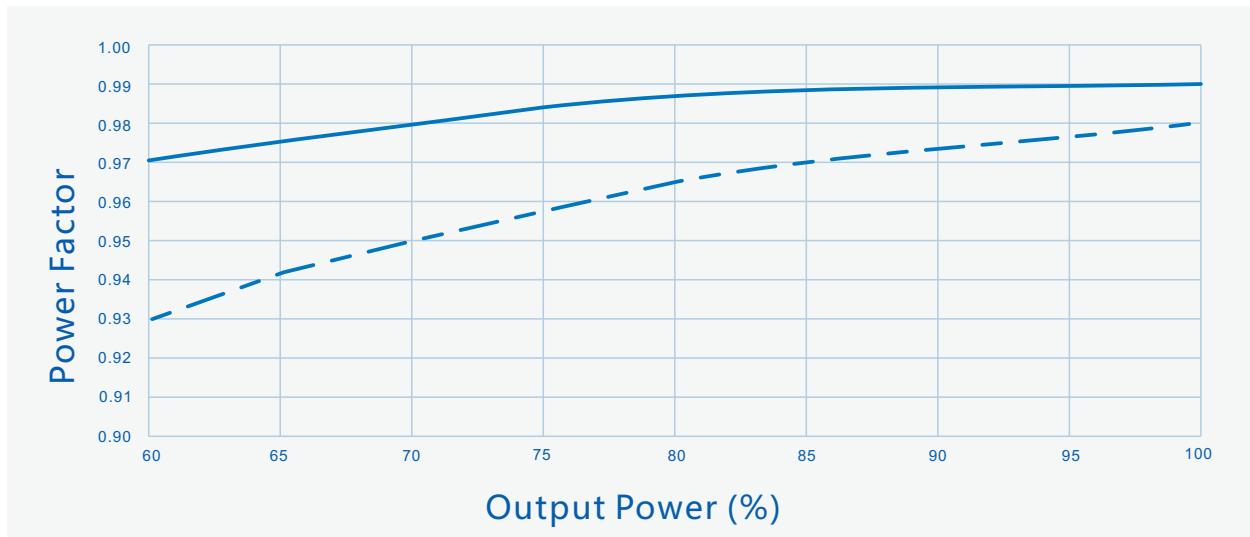

_____ $V_{in}=220V_{ac}$ - - - - $V_{in}=277V_{ac}$

SS-150GA Series LED Driver

Performance Curves:

THD Vs. Output Power

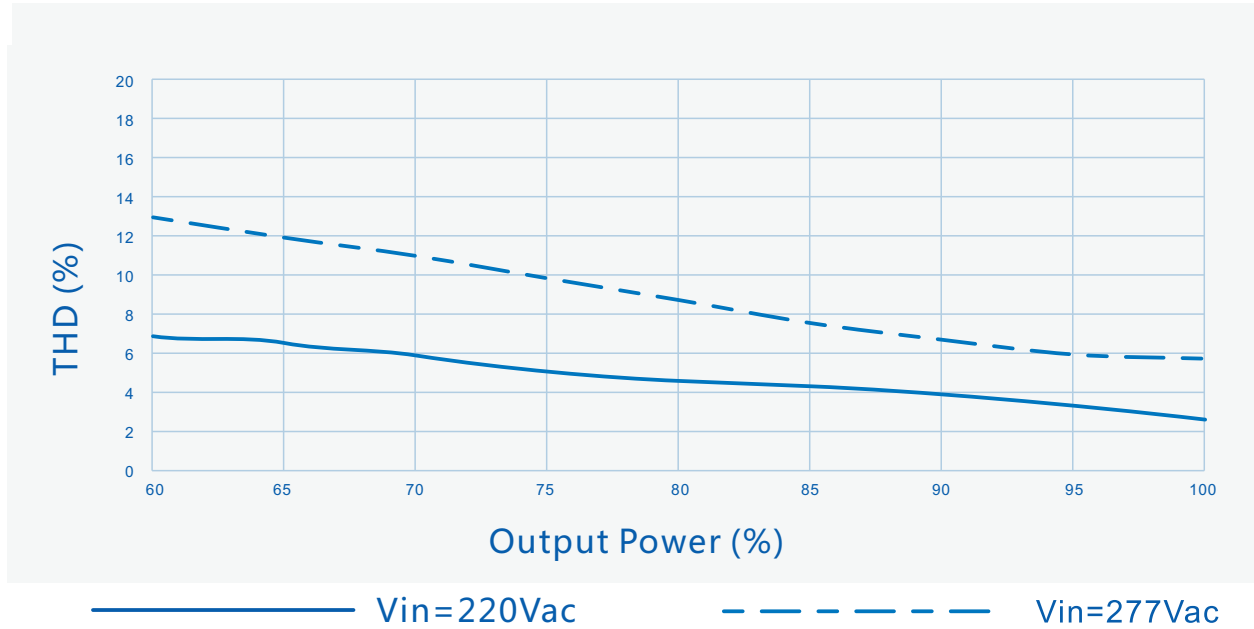

SS-150GA Series LED Driver

Performance Curves:

Output power Vs. Input Voltage (Ta Max.60°C)

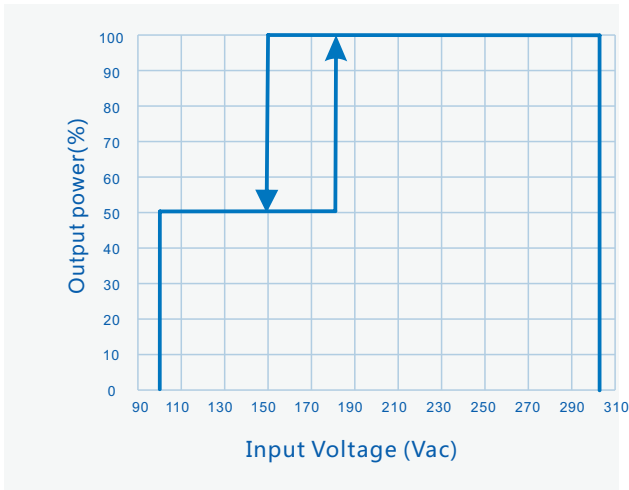

Output power Vs. Case Temperature

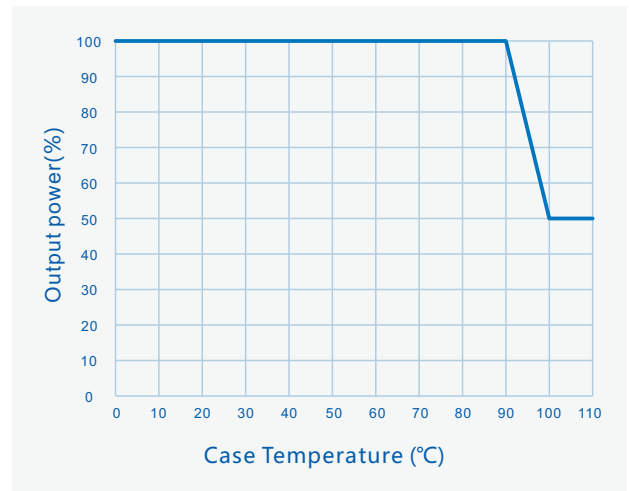

Output Power Vs. Dimming

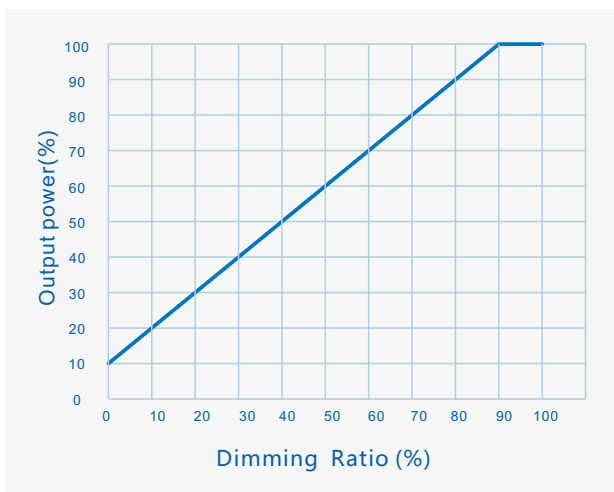

Lifetime Vs. Case Temperature

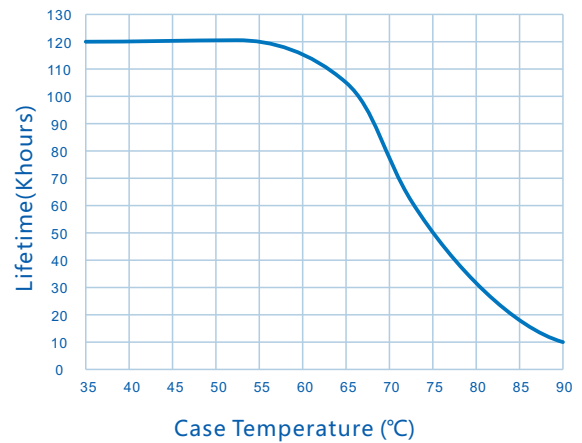

SS-150GA Series LED Driver

Performance Curves:

No load voltage VS. Output current

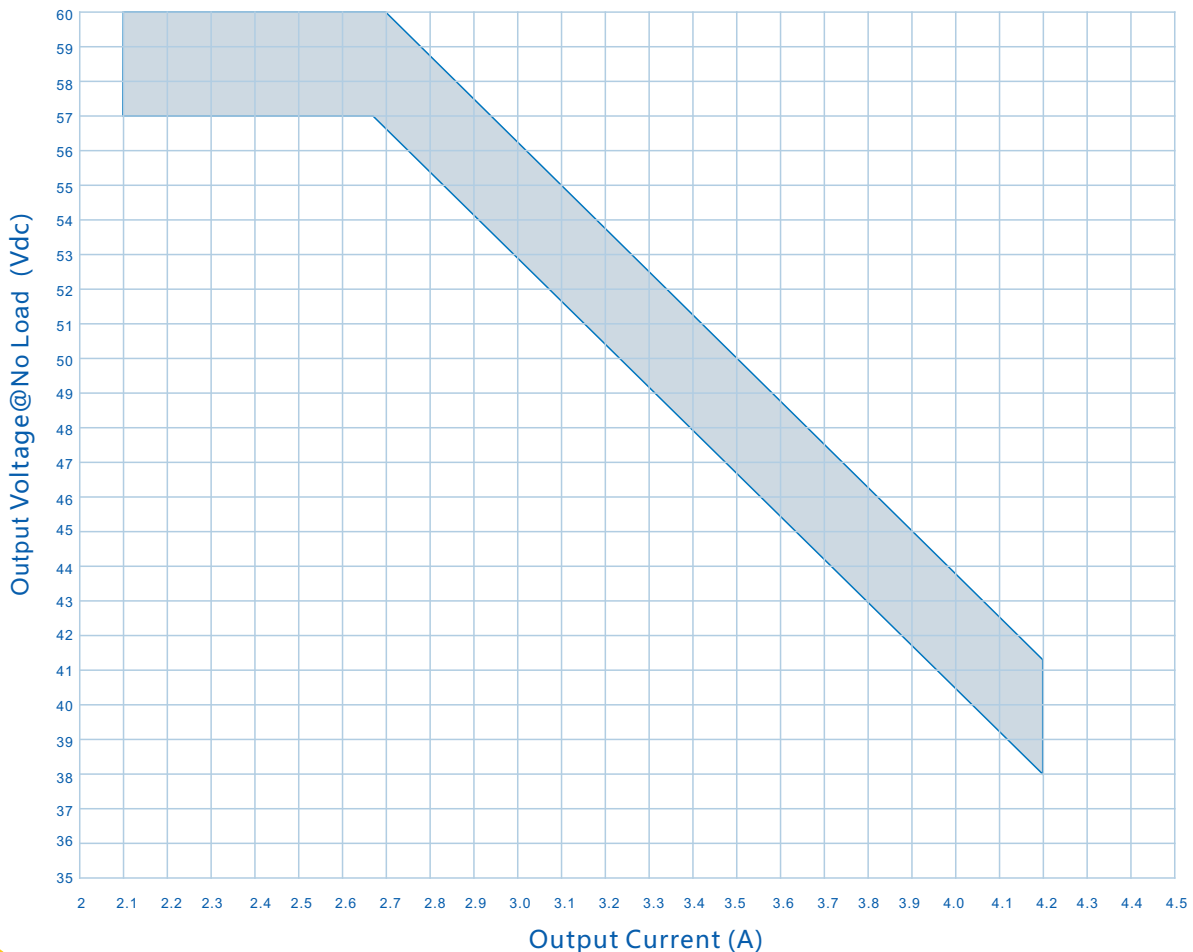

Warning:

Operation methods for adjusting output power:

Method 1: First adjusting the potentiometer to the minimum by rotating counterclockwise, then fine-tune the potentiometer to the specified power by rotating clockwise. If the specified power is exceeded during the adjustment process and the power is reduced from high value. Please adjusting the potentiometer to the minimum position and readjust it.

Method 2: First adjusting the potentiometer to the minimum position by rotating counterclockwise, then adjusting the potentiometer slowly by rotating clockwise and confirm whether driver's output current's corresponding no load voltage is in the shadow of upper drawings. If not, pls adjusting the potentiometer to the minimum position and readjust it.

SS-150GA Series LED Driver

Mechanical characteristics(Unit: mm)

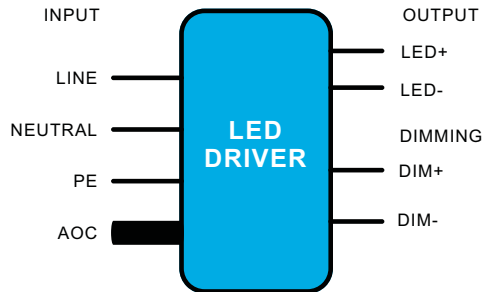

AC Input Cable(Lead Length outside enclosure 450±10mm):

Euro model: H05RN-F,3*1.0mm², O.D:7.4mm,Brown:L, Blue:N, Yellow/Green:PE

DC Output Cable(Lead Length outside enclosure 250±10mm):

Euro model: H05RN-F,2*1.0mm², O.D:7.0mm, Brown:V+, Blue:V-

DIM Cable(Lead Length outside enclosure 220±10mm):

Euro model: H05RN-F,2*0.75mm², O.D: 6.4mm , Brown : DIM+, Blue: DIM-

Name Description	Standard Code	mm(In.)
Case Length	L3	176(6.9)
Case Width	W1	66(2.6)
Case Height	H	39.5(1.6)
Overall Length	L1	200(7.87)
Mounting Hole Length	L2	185(7.28)
Mounting Hole Width	W2	32(1.26)
TC point position	X	30(1.18)
TC point position	Y	15(0.59)

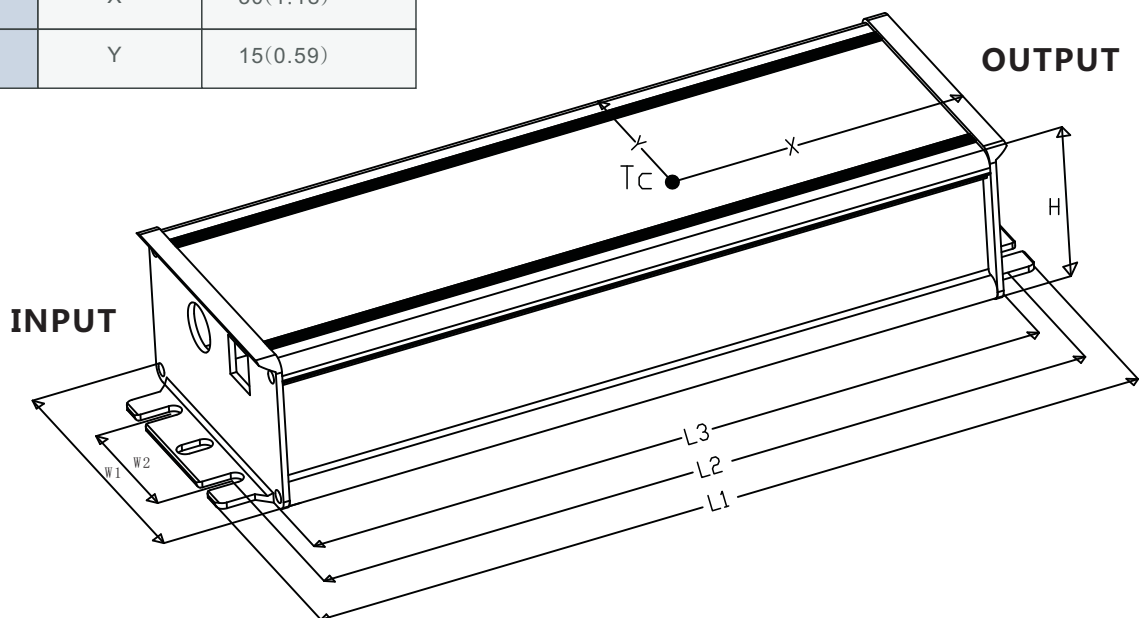

SS-150GA Series LED Driver



Installation Tips

1. Highly recommended to seal the adjustable hole with silicon glue(#704 preferred) after adjusting the driver's output current. Torsion with proper strength to avoid permanent damage to the potentiometer inside.
2. Dimming leads should be capped if not in use to avoid dimming circuit damage caused by external signals.

Package

- Outside carton dimension: L×W×H =500mm×390mm×170mm;
- 14PCS/Carton;
- Net weight/PC: 0.85kg;Gross weight/Carton: 13kg;
- Please refer to the product name, model number, manufacturer identification, quality inspection certificate, manufacturing date Etc. on the package. and LED power supply instruction manual in the package.

Transportation

Packaging is designed suitable for transportation by trucks, vessels and flights. The products should be shielded from direct sunshine, loaded/unloaded with caution.

Storage

The product storage meets the standard of the GB 3873 - 83.
Products should be rechecked if stock for over 1 year before installation.

RoHS

Products comply with European directive 2011/65/EC.

REVISION HISTORY

Version	Description of Change	Changed Date	Remark
V00	Original release	2018/10/18	
V01	Update the input line length to 450mm	2019/07/20	

